





















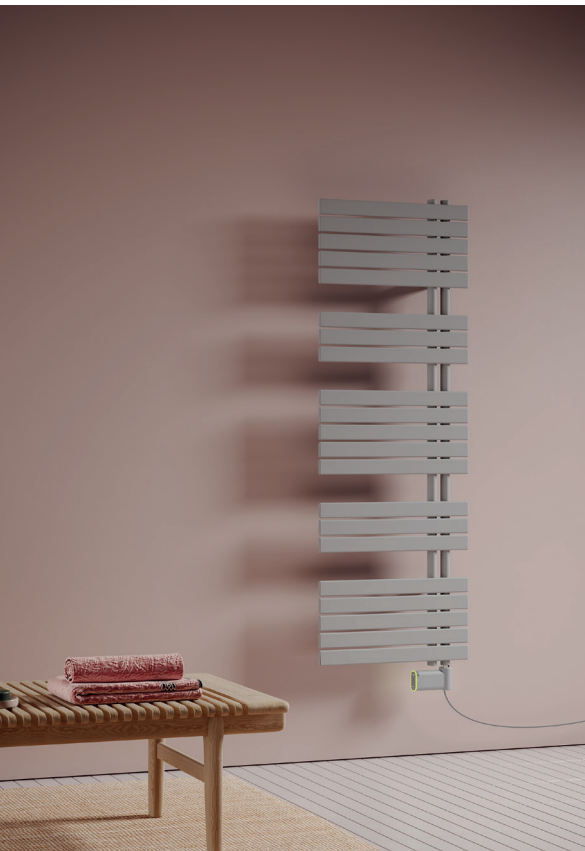

IRSAP smart

NOW
IRSAP

-  Guida rapida radiatori elettrici
-  Quick guide for electric radiators
-  Guide rapide des radiateurs électriques
-  Kurzanleitung zu elektrischen Heizkörpern
-  Guía rápida para radiadores eléctricos
-  Ghid rapid pentru calorifere electrice
-  Krótki przewodnik po grzejnikach elektrycznych

-  Per l'installazione del radiatore, fare riferimento al foglio istruzioni posto all'interno dell'imballo.
-  To mount the radiator, see the assembly instruction leaflet included inside the packaging.
-  Pour le montage du radiateur, reportez-vous à la fiche d'instructions située à l'intérieur de l'emballage.
-  Zur Montage des Kühlers, siehe die Montageanleitung in der Verpackung.
-  Para montar el radiador, consulte la hoja de instrucciones que se encuentra dentro del embalaje.
-  Pentru montarea radiatorului, consultați fișa de instrucțiuni din ambalaj.
-  Aby zamontować grzejnik, zapoznaj się z ulotką instrukcji montażu dołączoną do opakowania.



-  Per l'installazione del radiatore, fare riferimento al foglio istruzioni posto all'interno dell'imballo.
-  To mount the radiator, see the assembly instruction leaflet included inside the packaging.
-  Pour le montage du radiateur, reportez-vous à la fiche d'instructions située à l'intérieur de l'emballage.
-  Zur Montage des Kühlers, siehe die Montageanleitung in der Verpackung.
-  Para montar el radiador, consulte la hoja de instrucciones que se encuentra dentro del embalaje.
-  Pentru montarea radiatorului, consultați fișa de instrucțiuni din ambalaj.
-  Aby zamontować grzejnik, zapoznaj się z ulotką instrukcji montażu dołączoną do opakowania.



Il radiatore elettrico più evoluto di sempre

App IRSAP NOW - Scarica l'App da App Store o Play Store.

Smart pairing - Connetti il radiatore elettrico WiFi seguendo la procedura in App.

Blocco Modifiche Manuali - Impedisce variazioni manuali dalla pulsantiera.

Programmazione - Programma in modo semplice da smartphone la temperatura degli ambienti secondo le tue abitudini.

Sensore qualità dell'aria - Il tuo radiatore elettrico smart verifica la qualità dell'aria nella stanza. ★

LED Multicolor - Scegli il colore del LED del tuo radiatore elettrico smart direttamente dal tuo smartphone. ★★



Guida pairing

The most evolved electric radiator ever

IRSAP NOW App - Download our App from App Store or Play Store.

Smart pairing - Connect the WiFi electric radiator following the procedure in the App.

Manual Changes Lock - Prevents manual changes from the hand control.

Programming - Easily set up the rooms temperature according to your habits.

Air quality sensor - Your smart electric radiator checks the air quality in the room. ★

Multicolor LED - Choose the LED color of your smart electric radiator directly from your smartphone. ★★



Pairing guide

Le radiateur électrique le plus avancé jamais conçu

IRSAP NOW App - Téléchargez l'App depuis l'App Store ou Play Store

Smart pairing - Connectez votre radiateur électrique WiFi en suivant la procédure en App.

Verrouillage Modifications Manuelles - Empêche des variations manuelles depuis le clavier.

Programmation - Programmez en toute simplicité à partir de votre smartphone la température des pièce selon vos habitudes.

Capteur de qualité de l'air - Votre radiateur électrique smart vérifie la qualité de l'air dans la pièce. ★

LED Multicolore - Choisissez la couleur de la LED de votre radiateur électrique smart directement de votre smartphone. ★★



Guide de
pairing

Der fortschrittlichste elektrische Heizkörper aller Zeiten

IRSAP NOW App - laden Sie die App aus dem App Store oder Play Store herunter.

Intelligentes Pairing - Verbinden Sie den WiFi-Heizkörper, indem Sie den Anweisungen in der App folgen.

Manuelle Änderungen sperren - Verhindert manuelle Änderungen über die Handbedienung.

Programmierung - Programmieren Sie die Raumtemperatur ganz einfach über Ihr Smartphone entsprechend Ihren Gewohnheiten.

Luftqualitätssensor - Ihre intelligente Elektroheizkörper prüft die Luftqualität im Raum. ★

Multicolor LED - Wählen Sie die LED-Farbe Ihres smarten Elektroheizkörpers direkt über Ihr Smartphone. ★★



Pairing-Ratgeber

El radiador eléctrico más avanzado de la historia

IRSAP NOW App - Descarga la App desde App Store o Play Store.

Smart pairing - Vincula tu radiador eléctrico siguiendo el procedimiento en la App.

Bloqueo de cambios manuales - Impide los cambios manuales desde el teclado.

Programación - Programa de forma sencilla la temperatura del ambiente desde tu smartphone según tus hábitos.

Sensor de Calidad del aire - Tu radiador eléctrico smart verifica la calidad del aire en la estancia. 

LED Multicolor - Selecciona el color LED de tu radiador eléctrico smart directamente desde tu smartphone.  



Guía Pairing

Cel mai avansat radiator electric de pâna acum

Aplicatia IRSAP NOW - Descarcati aplicatia din App Store sau Play Store.

Asociere Smart - Conectati radiatorul electric WiFi, urmand procedura din aplicatie

Blocarea modificarilor manuale - Impiedica setarea manuala de la butoane.

Programare - Programați cu ușurință temperatura camerei de pe smartphone în funcție de obiceiurile dvs.

Senzor de calitate a aerului - Radiatorul dvs. electric inteligent verifică calitatea aerului din cameră. 

LED multicolor - Alegeți culoarea LED-ului radiatorului electric inteligent direct de pe smartphone.  



Ghid pentru asociere

Najbardziej zaawansowany grzejnik elektryczny w historii



Aplikacja IRSAP NOW - Pobierz aplikację z App Store lub Play Store.

Inteligentne parowanie - Podłącz grzejnik elektryczny przez wifi, postępując zgodnie z instrukcjami w aplikacji.

Blokada ręcznej modyfikacji - Wyłącza możliwość ręcznej modyfikacji z poziomu przycisków.

Programowanie - Łatwo ustaw temperaturę w pomieszczeniu, zgodnie z własnymi przyzwyczajeniami.

Czujnik jakości powietrza - Twój inteligentny grzejnik elektryczny sprawdza jakość powietrza w pomieszczeniu. 

Wielokolorowa dioda LED - Wybierz kolor diody LED swojego inteligentnego grzejnika elektrycznego bezpośrednio ze swojego smartfona.  



Przewodnik parowania

 Sax - Piano - Polygon - Origin

  Sax - Piano - Polygon - Origin - LED

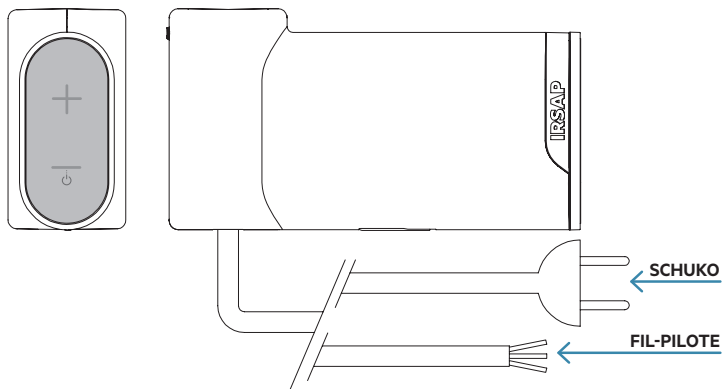

Tasti

- + Aumento setpoint
- Diminuzione setpoint
- ⏻ Standby: Premere sino a quando il LED diventa viola

Boutons

- + Augmenter le point de consigne
- Diminuer le point de consigne
- ⏻ Standby: Appuyer jusqu'à ce que la LED devienne violette.

Botones

- + Aumentar
- Disminuir
- ⏻ Standby: Pulsar hasta que el led se vuelva púrpura

Przyciski

- + Zwiększenie wartości
- Zmniejszenie wartości
- ⏻ Tryb czuwania: Naciśnij, aż dioda LED zmieni kolor na fioletowy.

Buttons

- + Setpoint increase
- Setpoint decrease
- ⏻ Standby: Press until LED turns purple.

Tasten

- + Sollwerterhöhung
- Sollwert verringern
- ⏻ Standby: Drücken Sie so lange, bis die LED violett leuchtet.

Butoane

- + Creșterea punctului de setare
- Scaderea punctului de setare
- ⏻ Așteptați: Apăsați până când LED-ul devine violet.

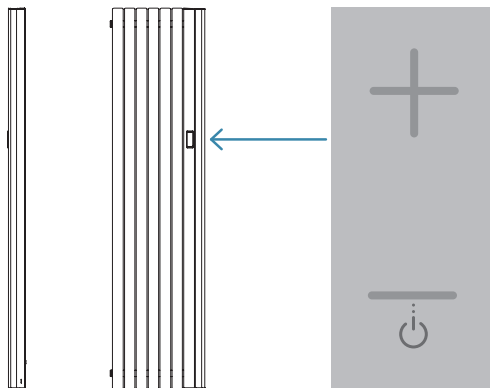

Tasti

- + Aumento setpoint
- Diminuzione setpoint
- ⏻ Standby: Premere sino a quando il LED diventa viola.

Boutons

- + Augmenter le point de consigne
- Diminuer le point de consigne
- ⏻ Standby: Appuyer jusqu'à ce que la LED devienne violette.

Botones

- + Aumentar
- Disminuir
- ⏻ Standby: Pulsar hasta que el led se vuelva púrpura

Przyciski

- + Zwiększenie wartości
- Zmniejszenie wartości
- ⏻ Tryb czuwania: Naciśnij, aż dioda LED zmieni kolor na fioletowy.

Buttons

- + Setpoint increase
- Setpoint decrease
- ⏻ Standby: Press until LED turns purple.

Tasten

- + Sollwerterhöhung
- Sollwert verringern
- ⏻ Standby: Drücken Sie so lange, bis die LED violett leuchtet.

Butoane

- + Creșterea punctului de setare
- Scaderea punctului de setare
- ⏻ Așteptați: Apăsați până când LED-ul devine violet.



APP IRSAP NOW



FOISTR1298M

cod. FOISTR1298M0225



www.irsap.com